



Heinzmann GmbH & Co. KG
Engine & Turbine Management

Am Haselbach 1
D-79677 Schönau
Germany







Phone +49 7673 8208 - 0
Fax +49 7673 8208 - 188
E-mail info@heinzmann.de
www.heinzmann.com

V.A.T. No.: DE145551926

HEINZMANN®
Engine & Turbine Management

Power supply with backup battery

NG 01-2 + NSV 01-2

  	<p>The appropriate manuals must be thoroughly studied before installation, initial start-up and maintenance.</p> <p>All instructions pertaining to the system and safety must be followed in full. Non-observance of the instructions may lead to injury to persons and/or material damage.</p> <p>HEINZMANN shall not be held liable for any damage caused through non-observance of instructions.</p> <p>Independent tests and inspections are of particular importance for all applications in which a malfunction could result in injury to persons or material damage.</p> <p>All examples and data, as well as all other information in this manual are there solely for the purpose of instruction and they may not be used for special application without the operator running independent tests and inspections beforehand.</p> <p>HEINZMANN does not guarantee, neither expressly nor tacitly, that the examples, data or other information in this manual is free from error, complies with industrial standards or fulfils the requirements of any special application.</p>
 	<p>To avoid any injury to persons and damage to systems, the following monitoring and protective systems must be provided:</p> <ul style="list-style-type: none"> – Overspeed protection independent of the rpm controller <p>HEINZMANN shall not be held liable for any damage caused through missing or insufficiently rated overspeed protection.</p> <ul style="list-style-type: none"> – thermal overload protection <p>The following must also be provided for alternator systems:</p> <ul style="list-style-type: none"> – Overcurrent protection – Protection against faulty synchronisation for excessively-large frequency, voltage or phase difference – Directional contactor <p>The reasons for overspeeding may be:</p> <ul style="list-style-type: none"> – Failure of positioning device, control unit or its auxiliary devices – Linkage sluggishness and jamming
 	<p>The following must be observed before an installation:</p> <ul style="list-style-type: none"> – Always disconnect the electrical mains supply before any interventions to the system. – Only use cable screening and mains supply connections that correspond with the <i>European Union EMC Directive</i> – Check the function of all installed protection and monitoring systems





 	<p>Please observe the following for electronically controlled injection (MVC):</p> <ul style="list-style-type: none"> – For common rail systems each injector line must be equipped with a separate mechanical flow-rate limiter – For unit pump (PLD) and pump-injector unit (PDE) systems, the fuel enable is first made possible by the solenoid valve's control plunger motion. This means that in the event of the control plunger sticking, the fuel supply to the injection valve is stopped.
 	<p>As soon as the positioning device receives power, it can actuate the controller output shaft automatically at any given time. The range of the controller shaft or control linkage must therefore be secured against unauthorised access.</p>
	<p>HEINZMANN expressly rejects any implied guarantee pertaining to any marketability or suitability for a special purpose, including in the event that HEINZMANN was notified of such a special purpose or the manual contains a reference to such a special purpose.</p>
	<p>HEINZMANN shall not be held liable for any indirect and direct damage nor for any incidental and consequential damage that results from application of any of the examples, data or miscellaneous information as given in this manual.</p>
	<p>HEINZMANN shall not provide any guarantee for the design and planning of the overall technical system. This is a matter of the operator its planners and its specialist engineers. They are also responsible for checking whether the performances of our devices match the intended purpose. The operator is also responsible for a correct initial start-up of the overall system.</p>

Table of Contents

	Page
1 Application	1
2 Technical data	2
3 Method of operation	3
4 Block diagram	4
5 Wiring	5
6 Dimensions	6
7 Adjustments	7
8 Service	7
9 How to order	7
10 Download of Manuals	8

1 Application

The power supply with backup battery NG 01-2 + NSV 01-2 is mainly used for the Heinzmann range of speed governors up to the E-30 size. This type of power supply should be used when a break-free governor operation is required in case of mains failure (e.g. marine applications).

For governors of the size E-64 and E-90 the unit NG02 + NSV02 should be used. This unit is designed for higher capacity.

If no battery backup is needed, the units NG01 and NG02 may be used.

2 Technical data

Voltage input	3 × 440V~ ±10% phase to phase or 3 × 380V~ ±10% phase to phase or 3 × 220V~ ±10% phase to phase or 3 × 190V~ ±10% phase to phase
frequency	50/60 Hz
power consumption	max. 320 VA per phase
output voltage	approx. 25 V=
output current	max. 8 amps
ripple	< 10%
battery voltage	22 V=
battery charge	5 Ah (amperes × hours)
battery life	200 charging cycles @ 100% decharging 700 charging cycles @ 60% decharging 8 years when fully charged
temperature range	- 40 °C to + 45 °C for a short time up to + 55 °C
humidity	up to 100%
protection grade	IP44
weight	approx 36 kg (80 lbs)
alarm output	phase failure mains failure charging failure battery voltage low
rating for alarm relay contacts	5 amps @ 250 V~ 2 amps @ 380 V~ 5 amps @ 30V=

3 Method of operation

The power supply with battery backup NG01-2 + NSV01-2 transforms the mains voltage to a lower voltage. This voltage is rectified and then put through a voltage controller to get a stabilised voltage.

In case of mains failure the unit will automatically switch over to battery operation. This is monitored with a relay and may be used for alarming a central control station. In normal operation the battery will be charged automatically with an internal charging circuit.

If a failure occurs it will be detected by an internal alarm circuit and the failure will be monitored with alarm relays. This information may then be transferred to a central control station. The alarm indication is done for protection of the battery and works with on/off-switch in position "ON" only.

Alarm output relays: phase failure
 mains failure / battery operation
 battery voltage low
 battery full / charging

CAUTION

Always switch off the governor when the mains are disconnected or lost due to other reasons. This will protect from unintentionally discharging the battery.

4 Block diagram

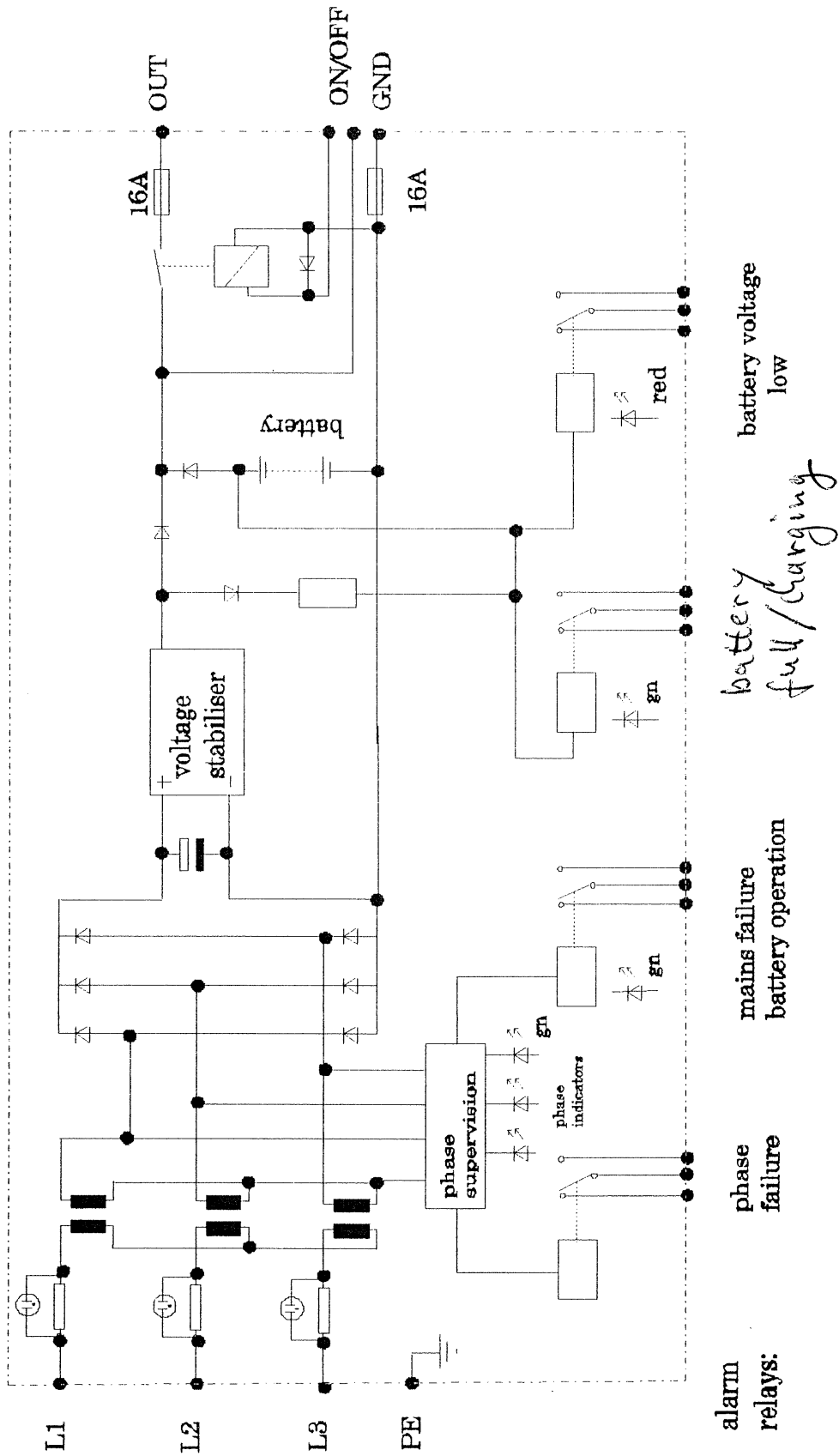

5 Wiring

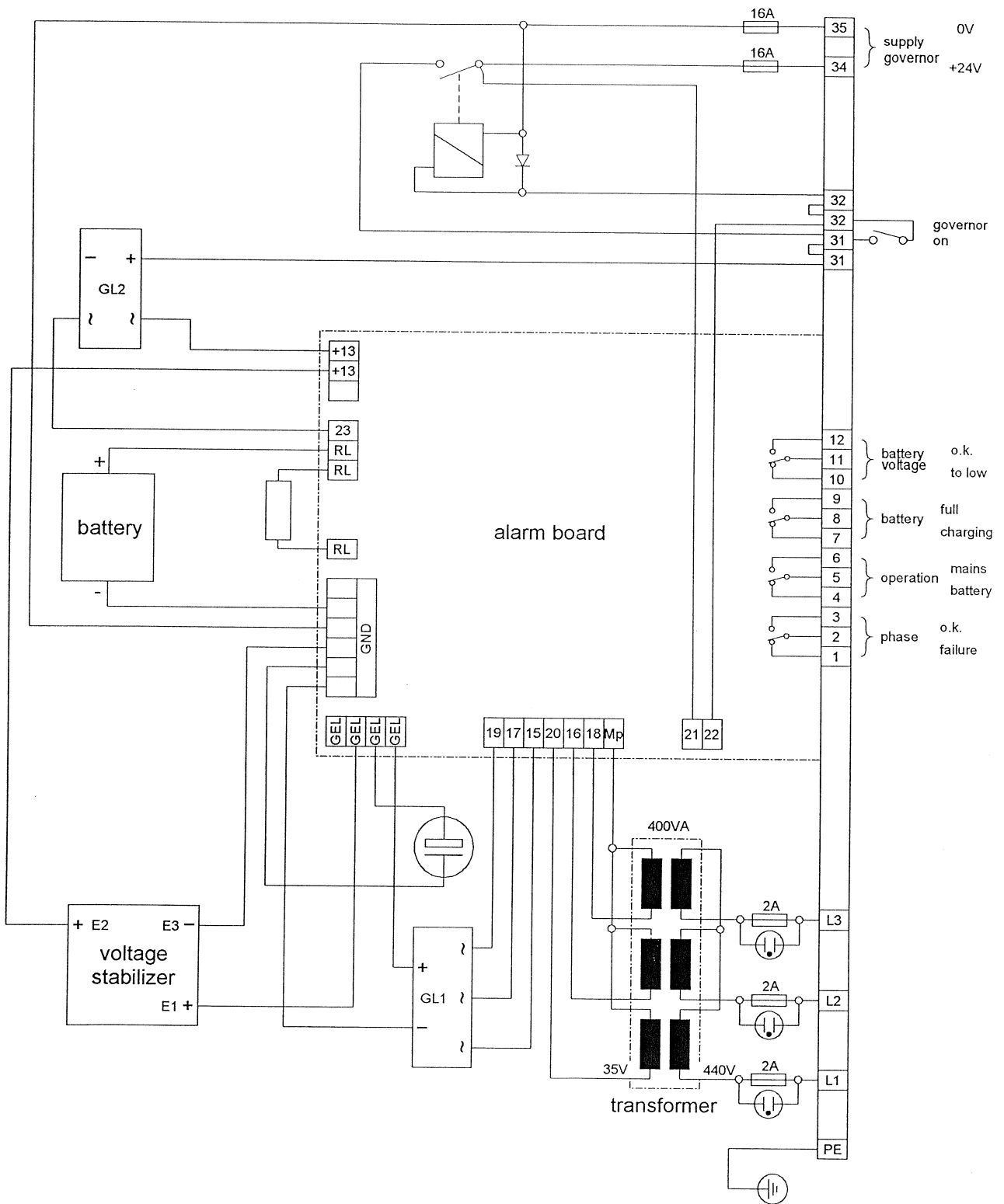

6 Dimensions

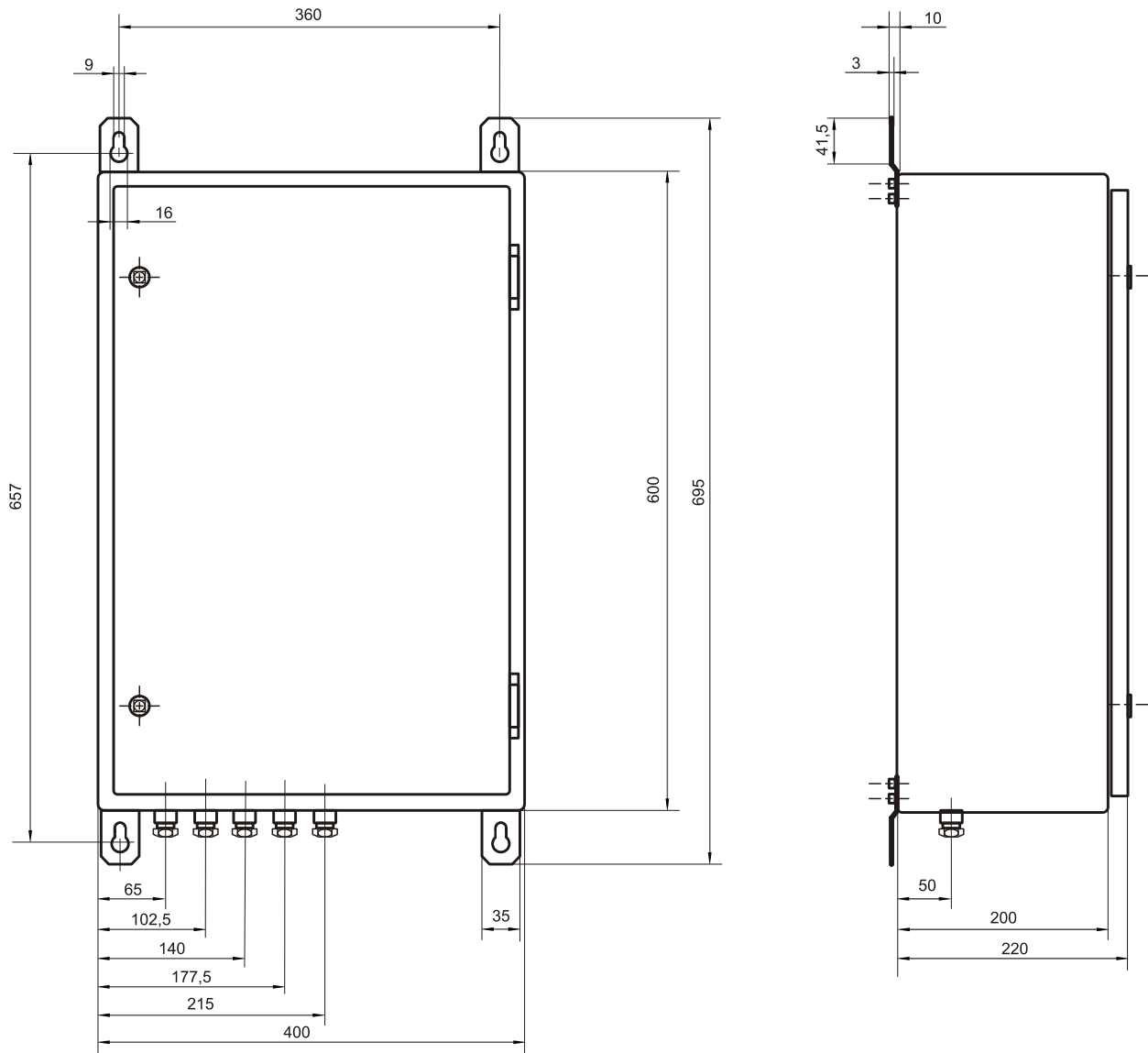

7 Adjustments

The unit is factory adjusted and needs no further adjustments.

CAUTION

Never try to re-adjust the unit without detailed circuit information. Wrong adjustments may result in personal injury or loss of life or damage to property due to high voltages and possible battery defects.

8 Service

The unit itself and the included batteries are maintenance-free. Service procedure to be done from time to time is to check the battery's charge.

Every three months run the set for at least 24 hours in normal operation, then switch to battery operation by removing the fuses. The set will continue to run with the governor supplied by the backup batteries. Keep the set running for 40 minutes in this mode, then switch back to normal operation by inserting the fuses.

If the alarm "battery voltage low" is given during this battery operated time, the batteries need to be changed.

CAUTION

Always switch off the governor when the mains are disconnected or lost due to other reasons. This will protect from unintentionally discharging the battery.

9 How to order

Please add the phase-to-phase supply voltage to the order code as follows:

$$\begin{array}{ccc} \text{NG 01-2} + \text{NSV 01-2} - \text{440V} & & \\ \Downarrow & & \Downarrow \\ \text{order code} & & \text{phase-to-phase voltage} \end{array}$$

10 Download of Manuals

Technical manuals can be downloaded in pdf-format from our homepage:

www.heinzmann.com

If the desired manual should not be available there, send an e-mail to:

info@heinzmann.de

or write to:

HEINZMANN GmbH & Co. KG

Technische Redaktion

Am Haselbach 1

D-79677 Schönau/Germany

Please include the following information:

- your name
- name and address of your company
- e-mail or address where you want the manuals to be sent to (if different from above)
- item code (as on front page, bottom right) and title of the desired manual
or alternatively the technical data of your HEINZMANN equipment

We would be pleased to receive your comments about the contents and presentation of our publications. Send your comments to the e-mail or address shown above please.