



Heinzmann GmbH & Co. KG
Engine & Turbine Management

Am Haselbach 1
D-79677 Schönau/Germany

Phone: +49 7673 8208-0
Fax: +49 7673 8208-188
Email: info@heinzmann.de
www.heinzmann.com

V.A.T. No.: DE145551926

HEINZMANN®
Engine & Turbine Management

Digital Generator Management (DGM-02)

THESEUS

Product Information

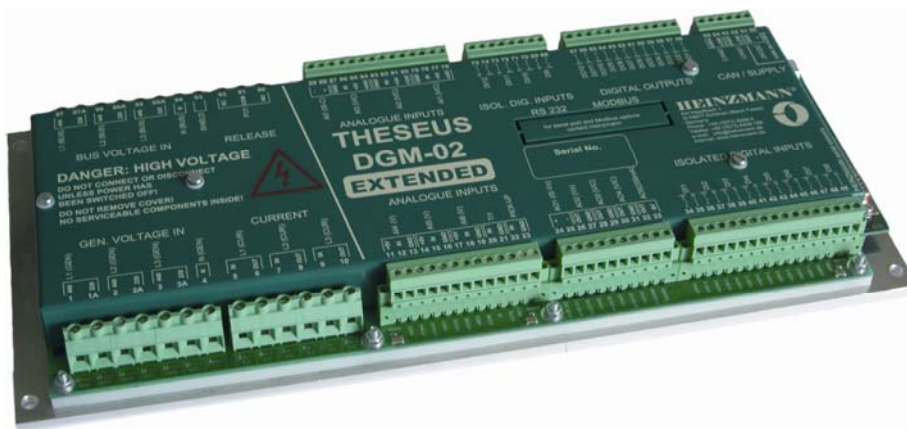

Table of Contents

	Page
1 General	1
1.1 General System Description	1
1.2 Digital Generator Management Variants.....	2
1.2.1 THESEUS BASIC	3
1.2.2 THESEUS MEDIUM	3
1.2.3 THESEUS EXTENDED.....	4
1.2.4 THESEUS GROUP for Group to Group Control.....	4
1.2.5 THESEUS GROUP for Group to Mains Control	5
2 Operation Modes and Applications	6
2.1 Generator Breaker Control	6
2.2 Bus Breaker Control	6
2.3 Mains Breaker Control	7
2.4 Operating Mode Automatic or Manual	8
2.5 Load Sharing of Island Parallel Generators in Isochronous Mode.....	8
2.6 Selection of installed Systems	9
3 Standard Functionality	10
3.1 Integrated Governors	10
3.2 Voltage and Current Measurement.....	10
3.3 Harmonics Filtering.....	10
3.4 Synchronizing.....	11
3.5 Circuit Breaker Status Monitoring	11
3.6 Circuit Breaker Control	12
3.7 Speed Offset-Signal to external Speed Governor.....	12
3.8 Voltage Offset-Signal to Voltage Regulator	12
3.9 Ramping Functions.....	13
3.10 Limiting Functions	13
3.11 Adjustable asymmetric Load in Island Parallel Operation.....	13
3.12 CAN Communication	14
3.13 Digital Outputs with Multiple Allocation Logic	14
3.14 Load Switching Points.....	14
3.15 Start-Stop Sequence.....	15
3.16 General Status Indication	15
3.17 Protective Functions for Generator Protection	16
3.18 Protective Functions for Engine Protection.....	17
3.19 Real-Time Clock and permanent Memory	17
3.20 ERROR Handling	18

3.20.1 General.....	18
3.20.2 Error Memory	18
4 Optional Functions.....	19
4.1 Integrated Speed Governor.....	19
4.2 Communication Protocols	19
5 DGM-02 Technical Specifications.....	20
5.1 General	20
5.2 Internal Displays.....	20
5.3 Measuring Inputs Generator / Busbar (TRMS).....	20
5.4 Relay Output.....	20
5.5 Isolated Digital Inputs	20
5.6 Digital Outputs	20
5.7 Analogue Inputs.....	21
5.8 Analogue Outputs.....	21
5.9 Speed Pickup Input.....	21
5.10 Communications.....	21
5.11 Environmental Tests.....	22
5.12 Marine Approvals.....	22
5.13 Housing.....	22
6 Dimensional Drawing.....	23
7 Example of Wiring Diagram	24
8 Accessories for DGM-02	25
8.1 HMI ARGOS.....	25
8.1.1 Technical Specifications	25
8.2 HMI PANOPTES	26
8.2.1 Application range.....	27
8.2.2 Features.....	27
8.2.3 Technical Specifications	27
8.2.4 Examples for standard Screens	28
8.3 CAN Repeater CR-01	29
8.3.1 Technical Specifications	29
8.4 DGM-IF-02 Interface to analogue Load Share Lines.....	30
8.4.1 Technical Specifications	30
8.5 HEINZMANN Speed Governor System.....	31
9 HEINZMANN Communication Tool DcDesk 2000	32

1 General

HEINZMANN's digital generator management control unit THESEUS DGM-02 is an all-rounder. Whether in island or mains parallel operation, single genset or group, there is an appropriate version for every application which, in conjunction with the HMI ARGOS or PANOPTES, provides a comfortable and user-friendly system. All THESEUS control units are marine classified.

THESEUS DGM-02 is available in four main variants: BASIC, MEDIUM, EXTENDED and GROUP. Each of these has a predetermined range of functions and communication interfaces suitable for user configuration via the powerful DcDesk 2000 communication software.

All but the BASIC variant also allow custom engineered solutions to meet specific needs.

Further optional enhancements such as Modbus, for interfacing to external PLC/SCADA packages as well as the PANOPTES touch-screen HMI, and integral speed governor, for interfacing with most standard positioner electronics, make THESEUS DGM-02 the complete generator management solution.

In conjunction with a wide range of Heinzmann products, THESEUS DGM-02 is at the heart of many reliable complete genset management solutions. With our highly esteemed DcDesk 2000 and customizable HMIs, the DGM-02 control unit is easy to set up and easy to operate.

This makes THESEUS DGM-02 fit perfectly for retrofits as well as for new installations, no matter what size of engine.

The Heinzmann THESEUS DGM-02 has been proven to provide accurate and reliable control for many customers. From a simple utility backup in the range of a few 10 kW to highly sophisticated installations of more than 10 MW per engine, land based, off-shore or marine, retrofit or new installation, combined with Heinzmann speed governors or not, the THESEUS DGM-02 satisfies manifold requirements.

1.1 General System Description

The control provides multiple input and output functions. For this purpose, the hardware includes a number of peripheral devices. The firmware is used for implementing the proper, flexible measuring and I/O functions to connect and operate an installation.

- Three-phase measuring inputs for measuring the voltage and frequency of the busbar and the generator, as well as the generator current,
- Analogue voltage and/or current inputs for connecting active adjusters and sensors,
- Analogue input to connect one passive temperature sensor,
- Speed pickup input for speed measurement,
- Analogue voltage and current outputs,
- Digital inputs to connect switch signals,

- Digital outputs to output switch and status signals,
- Relay output to trip the circuit of the power circuit breaker,
- Serial interface ISO 9141 to easily connect a HEINZMANN diagnostic tool,
- Two CAN Interfaces for THESEUS device communication and to connect HEINZMANN control equipment and external controls (PLC, SCADA),
- Optional serial RS-485 interface to connect HEINZMANN diagnostic tools or other external controls (PLC, SCADA),
- Real-time clock,
- Status indication,
- Supply and auxiliary voltages for sensors.

A DGM-02 control unit with its assigned circuit breaker can be used for a wide range of applications. It is not only suitable for controlling sets with engine and generator (which will form the basis of the following sections), but also to control and inspect circuit breakers for coupling busbars and coupling to the grid.

- Connection to busbar of one generator, each in island operation (Generator-to-Busbar) and parallel connection of further similar sets and/or mains parallel operation with an external mains circuit breaker.
- Special function: double synchronization with operation of a single active generator on the busbar and changeover to mains parallel or sync to shore operation with one additional mains circuit breaker which is controlled by the THESEUS control unit.
- Direct connection of the generator to the grid via generator circuit breaker.
- Parallel connection or coupling of two busbars with a number of generators, each by wattless connection and disconnection (Group-to-Group).
- Connection of generators and groups to grid and energy management operation for controlling import and export power (Group-to-Mains).

1.2 Digital Generator Management Variants

In order to provide the optimum functionality for all different applications, the control unit of the THESEUS series is available in five different versions: the BASIC, MEDIUM and EXTENDED versions for sets, the GROUP to GROUP and the GROUP to MAINS versions which are exclusively meant to control the bus circuit breakers. The BASIC version for small sets is mostly preconfigured at the factory, which means that a project support by HEINZMANN will usually be required and provided for projects extending to MEDIUM or larger installations.

1.2.1 THESEUS BASIC

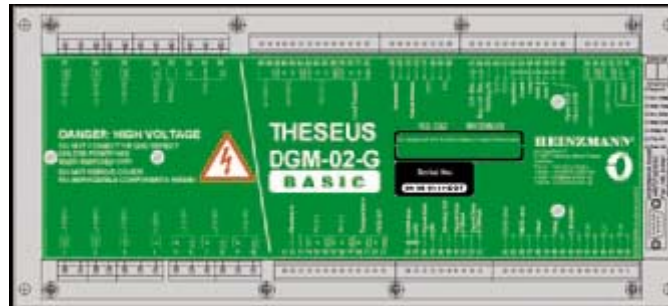

Figure 1: DGM-02 Basic

The BASIC variant is supplied with fixed settings for input and output connections in order to ensure easy and quick installation and commissioning. These assignments are printed on the cover of the unit to allow installation without a customized wiring diagram. This zero engineering philosophy will provide sufficient flexibility to cover most applications. A general wiring diagram is available under number ESK2645.

It can be used for voltages up to 480 V_{DC} phase to phase only.

1.2.2 THESEUS MEDIUM

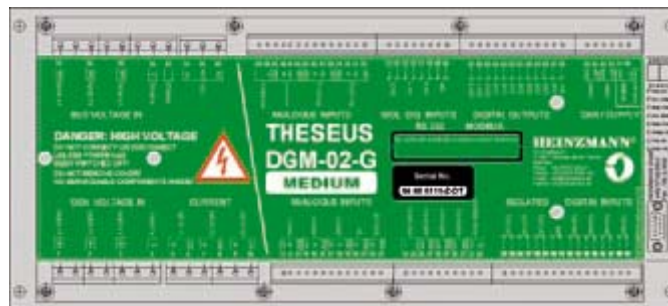

Figure 2: DGM-02 Medium

The MEDIUM variant comes with several well-proven standard sets of assignments to keep the amount of project related engineering at an acceptable level.

It can be used for voltages up to 480 V_{DC} phase to phase only.

1.2.3 THESEUS EXTENDED

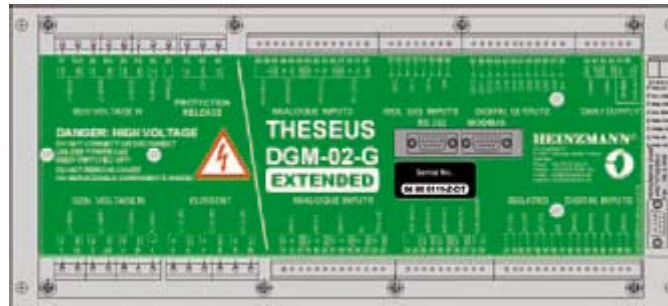

Figure 3: DGM-02 Extended

The EXTENDED version is for use in very sophisticated applications. It provides a wide-ranging means of configuration for any type of application and full support at any stage of a project.

It can be used for all kind of generator voltages.

1.2.4 THESEUS GROUP for Group to Group Control



Figure 4: DGM-02 Group to Group

The GROUP to GROUP version is designed to control a bus to bus breaker with high customisation level. This includes the synchronizing, soft load transfer, load sharing via the bus breaker and soft unloading with opening of breaker.

It can be used for all kind of bus voltages.

1.2.5 THESEUS GROUP for Group to Mains Control

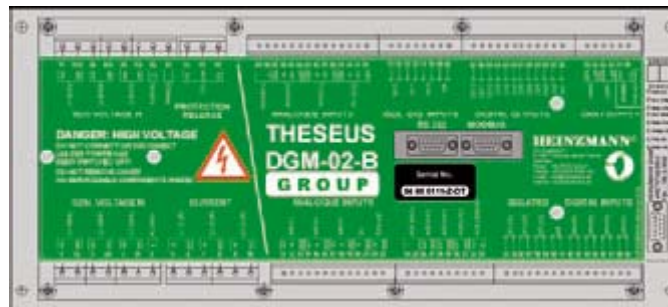

Figure 5: DGM-02 Group to Mains

The GROUP to MAINS version is designed to control a bus to mains breaker with high customisation level. This includes the synchronizing, peak shaving, import/export control, base load control, power factor control, mains failure detection and auto back synchronizing after mains restoration,.

It can be used for all kind of bus voltages.

2 Operation Modes and Applications

The DGM-02 is very flexible and can therefore work in different modes and applications. The most important ones are described in the following chapters.

2.1 Generator Breaker Control

The THESEUS DGM-02 for controlling the generator breaker provides the following main functions:

- Circuit breaker, status control, close, open.
- Synchronization by engine speed control and regulation of the generator voltage via the generator excitation system.
- Smooth loading and unloading of the generator via ramp functions and control of the delivered power by fuel supply regulation and reactive generator power control via the generator excitation system.
- Protective functions to prevent inadmissible loads by monitoring the operational data of the generator and tripping the circuit breaker, if necessary.
- Detection of outside operating conditions and modifications (such as island, mains parallel, power requirement) by other control units of the type THESEUS or other external circuit breakers and the relevant determination of its own setpoint values.

2.2 Bus Breaker Control

The THESEUS DGM-02 for controlling the bus breaker provides the following main functions:

- Circuit breaker, status control, close, open.
- Selection of a reference group for synchronizing.
- Synchronization by engine speed control of a group and regulation of the generator voltages of the generators in one group.
- Smooth loading and unloading of the group generators via ramp functions, until both groups are load sharing or the group circuit breaker is wattless.
- Protective functions to prevent inadmissible loads by monitoring the operating data and tripping the circuit breaker, if necessary.

The load sharing and VAR sharing of both groups is carried via two completely separate electrical systems. These can be either analogue or CAN load sharing lines. Even with both groups in parallel, these lines are not connected to each other. The advantages of this principle are:

- Faults in one side of the system do not affect the other side.
- This allows a greater overall physical length of load sharing lines.
- Groups can be cascaded one after another without limitation.

2.3 Mains Breaker Control

A Group-to-Mains device can control the energy flow in the overall system via the circuit breaker to the grid. For this purpose it carries out the following tasks:

- Circuit breaker, status control, close, open.
- Synchronization of the active groups by engine speed control and regulation of the generator voltages of the generators.
- Synchronization of generators and generator groups under load to the grid.
- Smooth loading and unloading of the generators via ramp functions, until the load via the mains breaker or the load of the gensets has reached its desired value or the mains circuit breaker is wattless.
- Control of the import or export of electrical power of a plant.
- Limiting the import to a maximum permissible value, e.g. in the sense of peak shaving.
- Presetting a base load setpoint value for all the generators.
- Control of the desired power factor of the power plant.
- Protective functions to prevent inadmissible loads by monitoring the operating data and tripping the mains breaker, if necessary.
- Detection of a mains failure with opening of breaker.
- Automatic re-synchronizing after mains restoration.

2.4 Operating Mode Automatic or Manual

The THESEUS DGM-02 control unit distinguishes between automatic (isochronous) mode and manual (droop) mode of operation. The generator management features are only available in automatic operation. In manual operation the DGM-02 control unit is passive, except for the protective functions, which are provided when these have been activated for manual operation.

Another possible exception is the automatic synchronization which still can be activated at manual mode. The operating mode will then be changed temporarily to automatic when the synchronizing command has been activated and will switch back to manual mode after the synchronization process is finished.

The auto mode can be switched off by the operator or is excluded by other exterior circumstances and only works if there are no malfunctions in any of the following system components:

- The THESEUS control unit hardware is free from defects, i.e. cyclic tests of the central hardware and software, as well as the peripheral hardware show no faults whatsoever.
- The operating voltage is adequate.
- There is no CAN Bus error at the CAN Bus using the HEINZMANN-CAN protocol (CAN port 1 and if necessary, CAN port 2).
- An external HEINZMANN speed governor connected via HZM-CAN or, if necessary, the internal speed governor is without fault and allows the auto mode.

2.5 Load Sharing of Island Parallel Generators in Isochronous Mode

Unlike generators in droop mode, those in isochronous mode of operation can share their electrical load equally at constant speed/frequency. For this type of load sharing devices like the HEINZMANN DGM-02 are needed.

The DGM-02 provides for load sharing via analogue load share lines as well as via CAN Bus. The analogue load sharing allows to connect the DGM-02 not only to one another, but also to non-DGM-02 load sharers. On the other hand, the use of CAN allows to reduce the amount of wiring in the system, since the CAN is also used for sharing reactive load. Using this feature makes cross current compensation wiring redundant and allows to run with voltage droop smaller than usual, too. Moreover, CAN provides highly fault resistant protocol and physical layer. Due to these advantages and for its electrical isolation, DGM-02 is using CAN for load sharing by default.

Isochronous load sharing is an automatically controlled activity, and hence only a few points need to be taken care of by system designers and operators.

2.6 Selection of installed Systems

- **Gold mines in Africa:** island generation up to 40 MW partly with DARDANOS EFI
- **Local supply in the Caribbean:** island generation with DARDANOS EFI
- **Floating tanks in Spain and the United Kingdom:** off-shore supply for floating units and platforms
- **Dredger:** marine power generation with pitch dependent load limit
- **Yachts in the United States:** marine power generation with shore synchronization
- **Military installation in the United Kingdom:** Military generation with redundant CAN for load sharing
- **Data centres in Sweden and the United Kingdom:** standard mains backup and mains backup with sophisticated feeder connection (4 x GROUP)
- **Sewage works in Germany:** mains backup and export with Dual Fuel and re-synchronization
- **Oil drilling applications worldwide:** island-based, off-shore and marine power for oil drilling and processing

3 Standard Functionality

The DGM-02 provides many functions as a standard, i.e. synchronizing, load ramping, kW load control, kW load sharing, PC based adjustment & monitoring, voltage-matching, PF control, kVAr load sharing, genset protection, automatic sequencing, CAN communication, real time alarm/data log, etc. All functions are described briefly in the following chapters.

3.1 Integrated Governors

All listed integrated governors have their own independent PID settings which can be done in wide ranges to be fully flexible for all kinds of applications.

- Speed governor (optional) with PID map and static correction
- Synchronizing governor (controlling the phase angle before closing the breaker)
- Voltage governor
- kW load sharing governor and load control according to load setpoint
- kVAr load sharing governor
- Power factor governor

3.2 Voltage and Current Measurement

Both Y and Δ (delta) applications are accepted. All phase connections must be completely implemented. The connection of the neutral conductor is optional.

While current is always metered via current transformers the metering of a voltage via voltage transformers is only possible with the EXTENDED and GROUP versions.

3.3 Harmonics Filtering

For both measurement paths of voltage and current one can switch on one filter each for reducing higher-frequency interferences. The filtering effect can be set to no harmonics filtering (OFF) / slight harmonics filtering / strong harmonics filtering.

3.4 Synchronizing

Coupling generators in parallel can be implemented with various synchronization methods, but the frequency, phase and voltage must always be matching. The following deviations before a connection in parallel are regarded as permissible:

- Frequency deviation a max. 2 % from rated frequency.
- Phase angle error is a max. $\pm 15^\circ$ between the zero crossings of the voltages.
- Potential difference a max. 10 % from rated voltage.

The following features are provided by the DGM-02 for synchronizing:

- Phase synchronization
- Slip synchronization
- Automatic re-synchronizing after mains restoration (only at group to mains unit)
- Automatic synchronization when DGM-02 is in manual mode (synchronizing with DGM-02, but load sharing in droop mode with speed setpoint offset to speed governor)
- Connection to dead busbar
- Double synchronizing which allows a single loaded genset also to synchronize to the mains
- Inhibit to close the breaker (stand-by synchronizing)

3.5 Circuit Breaker Status Monitoring

The status signals of a circuit breaker can be connected single or double pole.

On a one-pole, simply designed connection it is sufficient to connect one digital input with a status contact of the circuit breaker.

On a more complicated two-pole connection two digital inputs are connected with two status contacts of the circuit breaker.

The status of the circuit breaker is verified by measuring the current via the breaker. If the measured current is higher than 1% of rated current the DGM-02 assumes that the breaker is closed. If breaker status information and current measurement are not matching, the current measurement has higher priority and the DGM-02 continues the operation on its result and gives a status error alarm.

3.6 Circuit Breaker Control

There are two methods of closing and opening of the circuit breaker:

- With one permanent switching digital output the DGM-02 gives a turn-on-off signal to close and open the breaker.
- With one pulsed digital output the DGM-02 gives a command to close and with a second pulsed output it gives a command to open the circuit breaker.

3.7 Speed Offset-Signal to external Speed Governor

The DGM-02 can work together with digital and analogue speed governors of all existing manufacturers and brands. When the DGM-02 is active, the connected speed governor must always operate in isochron mode.

The following signal types can be used for the speed setpoint offset to speed governor:

- CAN bus (only in connection with Can bus prepared HEINZMANN speed governor)
- Voltage signal 0..5 V_{dc}
- Current signal 4..20 mA
- Digital outputs decrease / increase with adjustable pulse time

3.8 Voltage Offset-Signal to Voltage Regulator

The DGM-02 can work together with voltage regulators of all existing manufacturers and brands.

The following signal types can be used for the voltage setpoint offset to voltage regulator:

- Voltage signal -5..+5 V_{dc}
- Current signal 4..20 mA
- Digital outputs decrease / increase with adjustable pulse time

3.9 Ramping Functions

To assure smooth changeover of the setpoints, the DGM-02 provides several types of ramps.

- Start fuel limitation ramp (only at optional integrated speed governor)
- Start speed ramp (only at optional integrated speed governor)
- Speed ramp (only at optional integrated speed governor)
- 2 × up-loading ramps to load sharing setpoint after closing breaker or to requested setpoint
- 2 × down-loading ramps to minimum load

3.10 Limiting Functions

Limiting functions are available in the generator control section and in the optional speed governor section.

- Fixed starting fuel limitation at optional speed governor
- Variable starting fuel limitation at optional speed governor
- Temperature-dependent starting fuel limitation at optional speed governor
- Speed-dependent fuel limitation at optional speed governor
- Fixed load limitation at optional speed governor and generator control
- Adjustable load limitation at optional speed governor and generator control

3.11 Adjustable asymmetric Load in Island Parallel Operation

In some applications operating of one genset in asymmetric load is required for some time when all other gensets are still in load share mode. This is typically required at oil rig power plants where a high redundancy and safety philosophy is utilised.

The DGM-02 provides this functionality by using a variable external asymmetric load setpoint.

3.12 CAN Communication

All DGM-02 control units have two integrated CAN interfaces and may have an additional plug-on extension which provides an RS 485 interface for Modbus communication (RTU-Slave).

The first CAN port is isolated and intended for the HEINZMANN-CAN protocol as a standard, ie. the communication with other HEINZMANN devices is usually carried out via this port.

The second CAN port is not isolated and generally meant for communicating with superordinated systems, in general with devices made by external manufacturers which are responsible for the control and monitoring of the entire plant. In applications, where devices are connected to the second CAN port over long distances or where devices are fed from different power supplies, it is recommended that the DGM-02 is isolated from the bus by using a CAN repeater CR-01.

To ensure communication different kinds of standardized bus protocols have been implemented and can be selected according to the variant being used.

The Group-to-Group application is an exception. In this case the second CAN port is also intended for the HEINZMANN-CAN protocol in order to allow communication with the CAN Bus of the second Group to be performed. Consequently, data for both groups is available, although there is no physical connection

Another very helpful feature sets up communication with DcDesk 2000 via the CAN Bus and can view or modify parameters and measured values of the device and load firmware on several devices simultaneously.

It is possible to have up to 31 devices of each type connected to the network.

3.13 Digital Outputs with Multiple Allocation Logic

Up to 8 output values (measurement parameters which can only have the status “0” or “1”) can be used in combination with a “and” and “or” logic for a final signal output value of one digital output. The logic can also be assigned inverted. Thus it is possible to design a digital output function for almost every requirement.

3.14 Load Switching Points

There are four load switching points which are based on the same universal principle as the protective function, as far as the type of action is concerned. In all four cases the relative power of a set is rated with two switches for the underflow of a power limit and two switches for the overflow. The switch signals (measured values) can be used in external control jobs.

3.15 Start-Stop Sequence

The DGM-02 control unit allows comprehensive functions for starting and stopping the prime mover. To do so the operating cycle of the engine in general (from start to stop) as well as the distinction between diesel and gas driven engines in particular, are divided into three sections, the start-, generator-, and stop-phase.

With just one command triggered by digital input or via ARGOS / PANOPTES, the full starting sequence is activated up to final load sharing. At the load sharing mode it is possible to give a stop command directly and the full stop sequence is carried out until the engine has stopped.

Engine starting phases:

1. Pre-start on
2. Lube oil pump on
3. Coolant pump on
4. Cranking on
5. Ignition on
6. Fuel on
7. Warm-up at idle speed:

Generator phases:

1. Ramp-up to rated speed
2. Synchronize
3. Loading with load ramp up to load setpoint or load sharing
4. Unloading with load ramp to minimum load
5. Opening of circuit breaker

Engine stop phases:

1. Cool down engine on rated speed or idle speed
2. Shut-off diesel or gas supply immediately and ignition
3. Prevent any re-start before re-start timeout has elapsed.

3.16 General Status Indication

The status indicator is composed of a two-digit seven-segment display and eight LEDs which are permanently visible on the device.

3.17 Protective Functions for Generator Protection

All protective functions are based on the same principle using the following settings: trigger value, hysteresis, delay timer, separate activation, trip or warning, manual arming to test.

List of protective functions:

- All functions conform to ANSI and G59
- List of protective functions:
- Voltage matching ANSI 25
- Sync check (phase angle check) ANSI 25 (cannot be deactivated)
- Overload ANSI 32
- 2 x Reverse power ANSI 32R
- Over-excitation ANSI 24Q
- Excitation loss ANSI 40Q
- 2 x Overcurrent / time ANSI 51
- Overcurrent / instant (short circuit) ANSI 50
- Over- and under-frequency ANSI 81
- Overvoltage ANSI 59
- Undervoltage ANSI 27
- RoCoF (rate of change of frequency) ANSI 81R
- Vector shift ANSI 78
- Current balance ANSI 60
- Voltage balance ANSI 60
- Undercurrent ANSI 37
- Power supply deviation
- Additional phase difference check

3.18 Protective Functions for Engine Protection

The following implemented protective functions are also available at nearly all separate digital HEINZMANN speed governors. Depending on the function it will only give a warning or an opening of breaker request together with an engine stop request to the speed governor.

List of protective functions:

- Overspeed tripping and shutdown
- Coolant high temperature warning
- Oil high temperature warning
- Exhaust gas high temperature warning
- Speed-dependent oil pressure monitoring with warning and tripping curve
- Speed-dependent coolant pressure monitoring with warning and tripping curve
- Fuel low pressure warning
- Coolant low level warning
- Actual load deviation to load setpoint warning

3.19 Real-Time Clock and permanent Memory

The THESEUS control unit is provided with a real-time clock which allows - among other functions - to record any error that has occurred and indicate the time of occurrence in the error memory. The error memory is located in the same component. A lithium battery ensures retention of data irrespective of the power supply of the equipment.

The following data can be measured from the DGM-02:

- kW hours counter
- kVAr hours counter
- Genset operating hours counter
- Breaker closed operating hours
- Engine start counter
- Breaker close counter

3.20 ERROR Handling

3.20.1 General

The DGM-02 provides an integrated error monitoring system distinguishing between two types of alarms which are common (or non-critical) and fatal (or critical). They can be issued via digital outputs and linked with an optical or acoustic signal. The alarms can be assigned to closed or open contact active.

It is also possible to make a first diagnosis via the two-digit seven segment display.

If a sensor fails (e.g. by short circuit or cable break), the control will read voltages or currents lying outside the normal measuring range and creates an error. For any detected error, the respective response to this error can be modified by appropriate configuration which will allow to adjust the control's behaviour to the specific application and mode of operation in case of failure.

3.20.2 Error Memory

When the control is powered down it will lose any existing information on actual errors. In order to be able to check which errors have occurred, a permanent error memory has been incorporated in the control.

Any errors that have occurred at least once are stored there, including the time of their very first and last occurrence and number of occurrences since the error memory had last been cleared. In addition, up to 8 environmental data referring to the last occurrence may be recorded for each error.

4 Optional Functions

4.1 Integrated Speed Governor

The optional integrated speed governor provides all the functions of a standard digital HEINZMANN speed governor. It therefore includes all functions such as PID map, different starting fuel limitations, adjustable droop, speed ramps, limiting curves, etc.

All hydraulically driven actuators or electronically driven positioner actuators existing on the market which use an analogue or PWM position setpoint signal can be controlled by the internal speed governor.

To use the DGM-02's speed governor option and for proper use of the overspeed detection as well as for the complete functionality of the start-stop sequence, a speed probe must be connected to the DGM-02. An inductive (magnetic) HEINZMANN speed pickup type should be used for preference.

4.2 Communication Protocols

To communicate with external control or monitoring devices, the following different communication protocols are available on request:

- Modbus or SAE J1939
- CAN DeviceNet
- CAN open
- CAN SAE-J1939

5 DGM-02 Technical Specifications

5.1 General

Operating voltage	24 V _{dc} (18..33 V _{dc})
Power consumption	maximum 5 W
Operating ambient temperature	-40 °C to +70 °C

5.2 Internal Displays

Status indicator	8 LED
Error display	7-segment, 2-digit

5.3 Measuring Inputs Generator / Busbar (TRMS)

3 × generator voltage + neutral	100..240 V _{ac} phase/phase and 240..480 V _{ac} phase/phase
3 × bus voltage + neutral	100..240 V _{ac} phase/phase and 240..480 V _{ac} phase/phase
Connection configuration	3 phases, 3 or 4 wires (Δ / Y)
Current input nominal value (isolated) linear measuring range	1 A _{ac} or 5 A _{ac} 1.8 × I _{nominal}
Accuracy voltage / current	class 1
Frequency	45..65 Hz, nominal: 50 / 60 Hz

5.4 Relay Output

Voltage / current rating	24 V _{dc} / 8 A, 240 V _{ac} / 8 A
--------------------------	---

5.5 Isolated Digital Inputs (1..12)

	floating
Input voltage (OFF / ON) / R _I	0..3 V _{dc} / 6..40 V _{dc} / 5 kΩ

5.6 Digital Outputs (1..12)

	low side switching
Maximum current of outputs 1..8	500 mA
Maximum current of outputs 9..12	1 A
Configurable as PWM	outputs 9..12

5.7 Analogue Inputs

		free scalable
Inputs 1..3	as voltage inputs, signal / R_I	0..5 V_{dc} / 47 k Ω
	as current inputs, signal / R_I	4..20 mA / 200 Ω
Inputs 4..6	as voltage inputs, signal / R_I	0..5 V_{dc} / 47 k Ω
Input 7 (isolated)		floating
	current signal / R_I	420 mA / 65 Ω
Temperature input		
	sensor types / R_I	PT 1000 or Ni 1000 / 1 k Ω at 5 V

5.8 Analogue Outputs

		free scalable
Output 1 (isolated)		floating
	voltage signal / burden minimum	-5..+5 V_{dc} / 200 Ω
	insulation voltage	500 V_{ac}
Output 2	voltage signal / burden minimum	-5..+5 V_{dc} / 200 Ω
Outputs 3..4	as voltage outputs	
	signal / burden minimum	0..5 V / 200 Ω
	as current outputs	
	signal / burden maximum	4..20 mA / 200 Ω
Output 5	current signal / burden maximum	0..200 mA / 75 Ω

5.9 Speed Pickup Input (for inductive Sensor)

Voltage	0.2..40 V_{ac}
Frequency	20..10000 Hz

5.10 Communications

CAN connection 1 (isolated, floating)	ISO 11898, CAN2.0B (extended ID)
CAN connection 2	ISO 11898, CAN2.0B (extended ID)
Interface HEINZMANN communication	ISO 9141 (RS-232) up to 57.6 kBaud
Modbus RS-485 (isolated, floating), optional	EIA/TIA-485/422 up to 19.2 kBaud
RS-232, optional	EIA/TIA-232

5.11 Environmental Tests

Noise immunity	IEC 61000-4-2, -4-3, -4-4, -4-5, -4-6
Transient emissions	CISPR 16-2 +A1, +A2
Climate, vibration	IEC 60068-2-1, -2-2, -2-6, -2-30
High voltage	IEC 60947-2
Insulation	IEC 60092-504

5.12 Marine Approvals

Lloyd's Register EMEA	Type Approval Certificate No. 07/20036
Det Norske Veritas	Type Approval Certificate No. A-10962

5.13 Housing

	switchgear cabinet installation
Dimensions L × W × H	414.5 × 185 × 46.1 mm
Type of connection	screw connection
Conductor cross-section	measurement inputs and relay output 4.0 mm ² others 2.5 mm ²
Protection grade	IP 00
Weight	approx. 2.5 kg

6 Dimensional Drawing

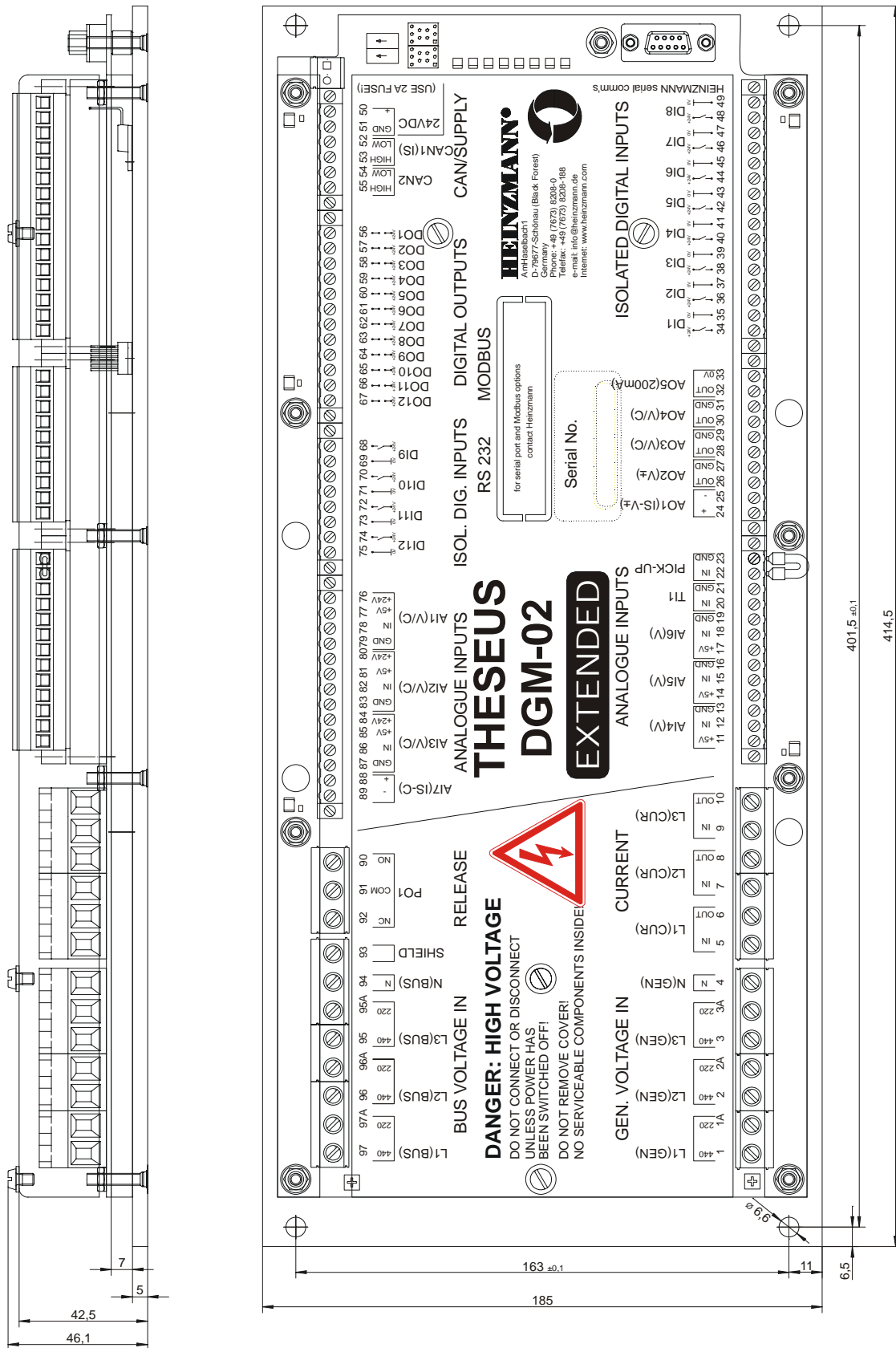

Figure 6: Dimensional drawing of DGM-02

7 Example of Wiring Diagram

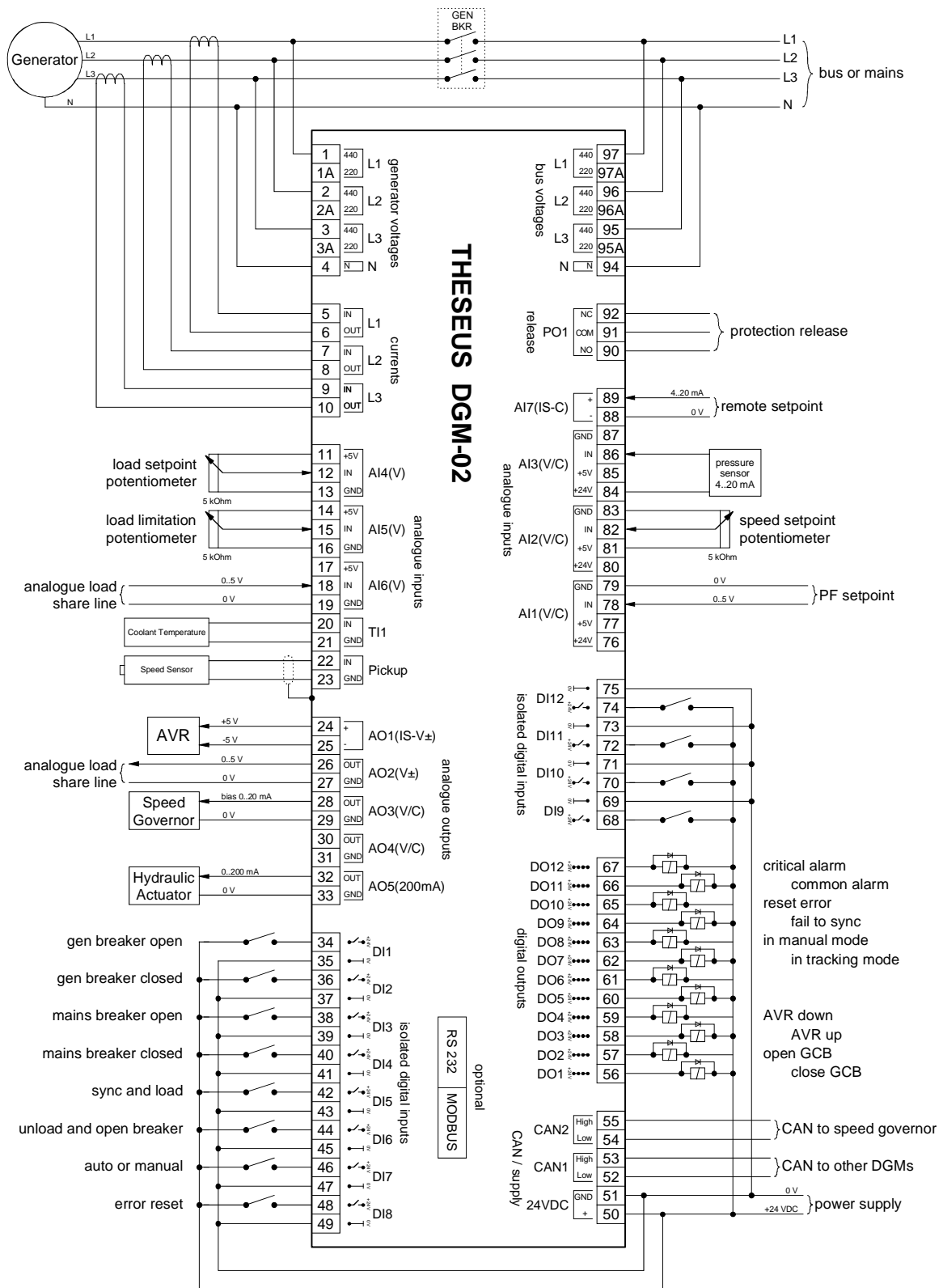

Figure 7: Exsample of wiring diagram

Please note that this wiring diagram is only an example. All analogue/digital inputs and outputs are free configurable and can therefore be different to the shown diagram.

8 Accessories for DGM-02

8.1 HMI ARGOS Control Panel for monitoring and changing Parameters



Figure 8: ARGOS

The HEINZMANN Digital Governor Panel ARGOS provides a human-machine-interface for operation of THESEUS DGM-02. It can be mounted into panel doors and console front panels.

ARGOS features a menu command structure and can be used either for continuous display of measuring values, such as genset operating status indications and 3-phase power metering, or it can be used to activate the start/stop sequences. During commissioning or trouble shooting it can be used for reading errors or changing parameters.

In addition, the device is equipped with eight LED's which can be free assigned and can be marked by inserting small strips of paper under the transparent covering.

ARGOS can be connected directly to a DGM-02 or it can be connected to the HEINZMANN CAN bus where a lot of DGMs can be linked together for common communication. In this case it is possible to communicate with any desired unit connected to this bus.

8.1.1 Technical Specifications

Operating Voltage	24 V DC (directly from control unit)
Current consumption	<100mA
LCD display	4 lines with 20 alphanumeric characters
Additional indication elements	8 LED's
Keypad	foil keyboard, 7 keys

Plug connector	8-pole, male
Operating ambient temperature	0 °C to +55 °C
Admissible air humidity	maximum 70 %
Protection grade	IP 43
Weight	0.5 kg
Dimensions	
Case and fram (W × H × D)	165 × 143 × 39.5 mm
Case body (W × H × D)	154 × 132 × 33.5 mm

8.2 HMI PANOPTES Touch Screen



Figure 9: PANOPTES

PANOPTES 02, as part of the HEINZMANN generator control system THESEUS, is a compact Human Machine Interface (HMI) for visualising data in the form of graphics, operating and controlling and it is suited for the control room and remote operation.

With its features of 10.4 or 5.7 inch full VGA TFT display, touch screen and a powerful PowerPC processor it is particularly suited to THESEUS applications but can equally be used with other systems.

A wide range of interfaces allows data exchange with PLC or SCADA via ETHERNET, CAN bus, RS485, or an optional PROFIBUS interface as well as a web visualisation. Optional digital and analogue I/O can be used to extend the control panel to do conventional PLC functions. For special purposes like alarm messaging and data logging an SD Card or USB memory stick can be used.

The data visualisation is normally performed by a number of standard screens. However, custom specific extensions can be provided to meet the needs of specific projects.

8.2.1 Application range

- Price-sensitive applications
- Local equipment cabinet operation
- Control room operation in small up to medium plant size
- Reducing of mechanical operation and instrumentation elements
- Summarisation of data to be displayed from different sources

8.2.2 Features

- Dialog panel and PLC controller in one device
- Compact and high functional Integrated display and control
- Wide range of interfaces
- Multifunctional I/O extension cards
- Sufficient memory even for complex applications
- Memory extension by SD Card Slot and USB
- Remote-controlling via web server, FTP and Email functionality
- Language selection

8.2.3 Technical Specifications

Supply voltage	24 V
Operating ambient temperature	0 °C to +50 °C
Processor	PowerPC CPU, 400 MHz
Memory	RAM: 128 MB Flash: 32 MB
Memory extension	SD Card Slot, optional up to 4 GB
Display size diagonal	10.4 inch (rectangular 8.3 x 6.2 inch) 5.7 inch (rectangular 4.5 x 3.4 inch)
Display type	VGA
Resolution	640 x 480
Display colours	65536
Operation	touch sensitive area, resistive matrix touch
Operating system	Linux with real-time extension

Interfaces

1 ETHERNET 10/100 Mbit/s

1 CAN, max. 1 Mbit/s

1 RS485

1 RS232

1 USB

1 PROFIBUS optional

Digital I/O

Miscellaneous, on request

Protocol

MODBUS, CANopen, PROFIBUS

Time

RTC

Protection grade

IP 65 front / IP 20 rear

Fitting dimensions

14.17 × 10.24 × 4.8 inch

(10.4 inch display type)

7.5 × 6.8 × 3.5 inch

(5.7 inch display type)

8.2.4 Examples for standard Screens

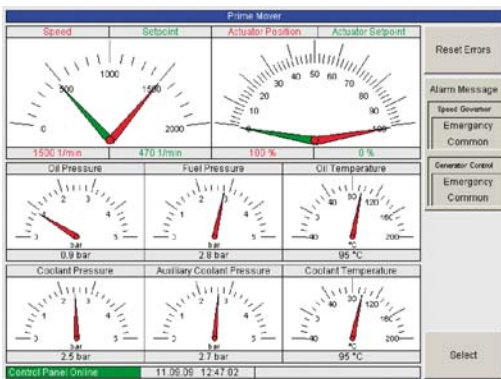

Figure 10: Screen for speed governor

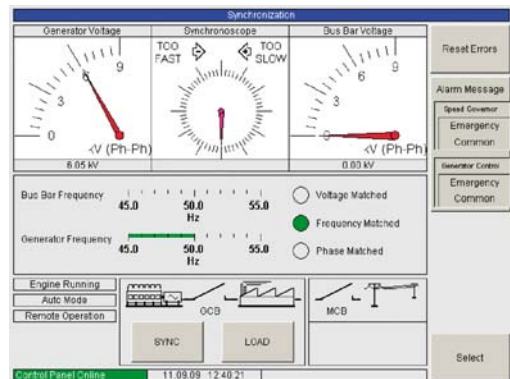

Figure 11: Screen for synchronizing

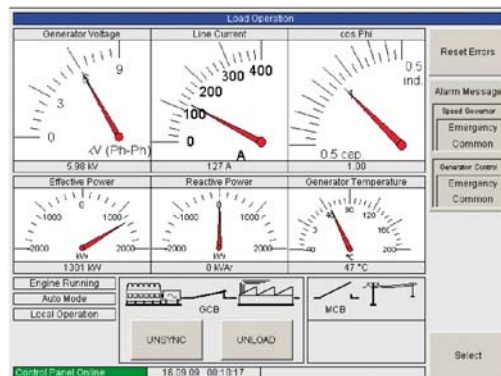

Figure 12: Screen for load measurement

8.3 CAN Repeater CR-01

The CR-01 is needed when optical isolation between 2 DGMs connected to the same bus is requested (different power supply potentials are existing at the installation) or when the total CAN bus length exceeds 400 meters. Thus communication failures or damage to equipment due to ground level shifting will be avoided.

Note: The CAN bus 1 connection at DGM 02 already has optical isolation.

The CR-01 is DIN rail mountable and must be placed close to the DGM-02 itself. It is vitally important to keep cable lengths for the CAN repeater to the DGM-02 as short as possible.



Figure 13: CR-01

8.3.1 Technical Specifications

Operating Voltage	24 V DC
Indication elements	2 LED's
Operating ambient temperature	0 °C to +50 °C
Admissible air humidity	maximum 70 %
Protection grade	IP 00
Weight	0.2 kg
Dimensions (W × H × D)	77 × 111 × 90 mm
Type of connection	screw connection
Conductor cross-section	2.5 mm ²
DIN rail	NS 32 or NS 35/7.5

8.4 DGM-IF-02 Interface to analogue Load Share Lines

Although the DGM-02 does use CAN Bus for active and reactive load sharing, it can optionally be connected to analogue load share lines via the interface DGM-IF-02.

The DGM-IF-02 is an isolated load share interface, which allows connection of the DGM-02 to analogue active or reactive load share equipment from HEINZMANN or others, as long as the maximum voltage range of the load share lines does not exceed $-6..+6 V_{dc}$.

Each interface needs one available analogue output and one available analogue input, both with a voltage range of $0..5V$ as well as one available digital output for connection to the DGM-02. These IOs can be assigned and adjusted at the DGM-02 to meet all kinds of existing load share line operating voltage ranges.

The DGM-IF-02 is DIN rail mountable and must be placed close to the DGM-02 itself.



Figure 14: DGM-IF-02

8.4.1 Technical Specifications

Operating Voltage	24 V DC
Output voltage to load share line	$-6..6 V$
Output impedance	15.5 k Ω
Indication elements	2 LED's
Operating ambient temperature	0 °C to +50 °C
Admissible air humidity	maximum 70 %
Protection grade	IP 00
Weight	0.15 kg
Dimensions (W × H × D)	42 × 111 × 50 mm

Type of connection	screw connection
Conductor cross-section	2.5 mm ²
DIN rail	NS 32 or NS 35/7.5

8.5 HEINZMANN Speed Governor System

The DGM-02 can operate with all HEINZMANN speed governors via analogue or increase/decrease signals.

Some of the digital HEINZMANN speed governors already provide communication via CAN as a standard feature. For all other digital governors we can add a special CAN board into the speed governor to be prepared for CAN communication.

In general, HEINZMANN recommends use of CAN communication to the speed governor if possible, thus allowing much additional information to be communicated between the DGM-02 and the speed governor, as well as the speed setpoint offset.

9 HEINZMANN Communication Tool DcDesk 2000

The HEINZMANN communication tool DcDesk 2000 is universally designed to communicate with all existing HEINZMANN digital control devices during commissioning and trouble shooting.

The connection between PC or laptop and control unit can be established using a serial interface or the CAN Bus with the HEINZMANN-CAN protocol.

Using the PC programme DcDesk 2000, it is possible to have several parameters continuously displayed and accessible to modification. The PC programme is also capable of displaying limitation curves, characteristics, etc, in graph form and can adjust them quickly and easily. The control data can be stored by the PC or downloaded from the PC to the control. A further advantage of the PC programme is its ability to visualize in high-resolution measured values as functions of time or as functions of each other. All of these values can be recorded to be evaluated later on and eventually printed out.

Thus, even without a control unit connected, it is possible to process a parameter set and evaluate the recorded data. Any parameter set generated in this way can later on be downloaded to the control unit.

Special windows are also provided by DcDesk 2000 in generator management application.

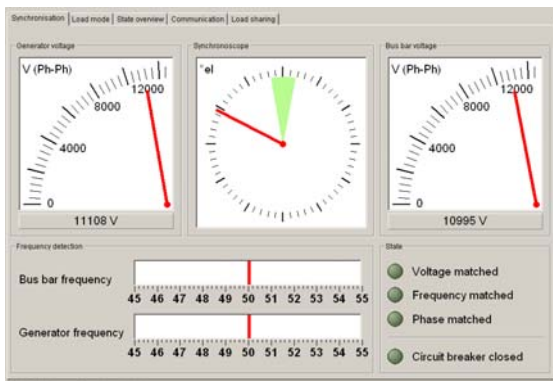

Figure 15: Window at synchronizing

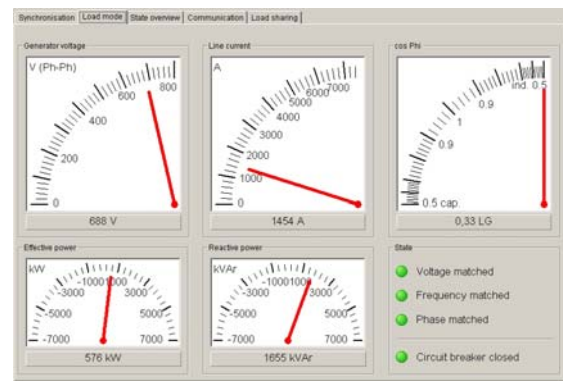

Figure 16: Window to measure generator load

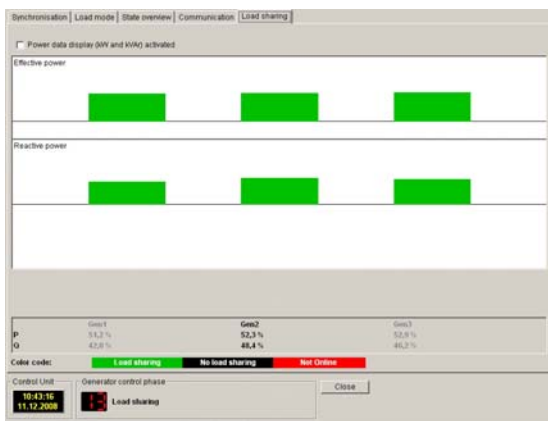

Figure 17: Window to monitor load sharing

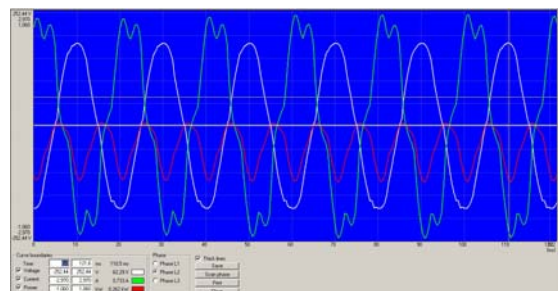

Figure 18: Window to scan the voltage and current